

# TruPulse® 200X

**LASER TECH**

## User's Manual

4th Edition



1.303.649.1000



ServiceCenter@LaserTech.com



6912 S. Quentin St, Suite A  
Centennial, CO 80112

@LaserTechnologyInc



@LaserTechnologyInc



@LaserTechInc\_



@LaserTechPro



@Laser-Technology



**Copyright Notice:**

Information in this document is subject to change without notice and does not represent a commitment on the part of Laser Technology Inc. No part of this manual may be reproduced in any form or by any means, electronic or mechanical, including photocopying, recording, or information storage and retrieval systems, for any purpose other than the purchaser's personal use, without the express written consent of Laser Technology, Inc.

Copyright © Laser Technology, Inc., 2024. All rights reserved.  
Unauthorized duplication, in whole or in part, is strictly prohibited.

Printed in the United States of America

Fourth Edition: January 2024

**Patents:**

This product is covered by pending patent applications and/or the following issued U.S. Patents:

6,445,444; 5,612,779; 6,057,910; 6,226,077; 5,652,651; 7,349,073.

**Trademarks:**

Criterion, Impulse, and TruPulse are trademarks of Laser Technology, Inc.

**LTI Contact Information:**

**Customer Support / Service:**

**Phone:** 1.303.649.1000  
1.877.696.2584 (North America)  
**Fax:** 1.303.649.9710  
**Email:** [servicecenter@lasertech.com](mailto:servicecenter@lasertech.com)

**Corporate Address:**

Laser Technology, Inc.  
6912 South Quentin Street, Suite A  
Centennial, CO 80112 USA

**Support, FAQ & Tech Documents:**

[www.lasertech.com/professional-measurement-products](http://www.lasertech.com/professional-measurement-products)

**RMA Request:**

[www.lasertech.com/customer-service](http://www.lasertech.com/customer-service)

**TruPulse 200X Reference Information:**

Record information about your TruPulse 200X in the table below.

	You can find this value:	Value
Serial Number	On the serial number sticker affixed to the TruPulse 200X or see <a href="#">Page 44</a> for information.	
Firmware Revision Number	See <a href="#">Page 31</a> for information.	

**Laser Technology, Inc.**  
**TruPulse® 200X**  
**User's Manual**

Languages

1. English
2. Español
3. Français
4. Deutsch
5. 日本語
6. 汉语被简化



## Table of Contents

<b>Precautions</b> .....	<b>3</b>
<b>Section 1 - Introducing the LTI TruPulse 200X</b> .....	<b>5</b>
Operating Modes .....	5
Unpacking Your TruPulse 200X.....	5
Understanding How the TruPulse 200X Works .....	6
Laser Range Sensor .....	6
Targets .....	6
TruTargeting.....	7
Tilt Sensor .....	8
<b>Section 2 - Quick Start</b> .....	<b>9</b>
<b>Section 3 - Basic Operations</b> .....	<b>10</b>
Installation .....	10
Battery Voltage Level .....	10
Buttons .....	11
Display Indicators.....	12
Display Indicator Test.....	14
Error Codes .....	15
Eyepiece .....	16
Focus Adjustment Ring.....	16
Foliage Filter .....	17
Measurement Point of Reference .....	17
Neck Strap.....	18
Serial Port .....	18
Restore Default Settings.....	19
<b>Section 4 – System Setup Mode</b> .....	<b>20</b>
Brightness .....	20
Units of Measure .....	21
Filter Mode .....	22
Continuous Mode.....	23
Targeting Modes.....	24
Gate.....	26
Baud Rate .....	28
Bluetooth.....	29
Firmware Revision Number.....	31
<b>Section 5 - Measurement Modes</b> .....	<b>32</b>
Distance Measurements.....	32
Notes about Measurements .....	33

Inclination Measurements .....	34
Percent Slope.....	34
Height Routine .....	35
2-Step Height Routine.....	38
2D Missing Line Routine .....	39
<b>Section 6 – Serial Interface.....</b>	<b>42</b>
Format Parameters .....	42
Serial Port .....	42
Download Message Format .....	42
Requests.....	43
Firmware Version ID Request (1).....	43
Firmware Version ID Request (2).....	44
Serial Number Request .....	44
Remote Trigger (RUN) Request.....	45
Remote Trigger (STOP) Request .....	45
<b>Download Message Formats.....</b>	<b>46</b>
Horizontal Vector (HV) Download Messages.....	46
Height (HT) Download Messages .....	47
Missing Line (ML) Download Messages .....	48
<b>Section 7 - Care &amp; Maintenance.....</b>	<b>49</b>
<b>Section 8 - Specifications.....</b>	<b>51</b>
<b>Section 9 - Main Display LED Characters .....</b>	<b>53</b>
<b>Section 10 – LTI Limited Warranty .....</b>	<b>55</b>
<b>Section 11 – Troubleshooting.....</b>	<b>56</b>

## **Precautions**

### **Avoid staring directly at the laser beam for prolonged periods.**

The TruPulse® 200X is designed to meet FDA eye safety requirements and is classified as eye-safe to Class 1 limits, which means that virtually no hazard is associated with directly viewing the laser output under normal conditions. As with any laser device, however, reasonable precautions should be taken in its operation. It is recommended that you avoid staring into the transmit aperture while firing the laser. The use of optical instruments with this product may increase eye hazard.

### **Never attempt to view the sun through the scope.**

Looking at sun through the scope may permanently damage your eyes.

### **Never point the unit directly at the sun.**

Exposing the lens system to direct sunlight, even for a brief period, may permanently damage the internal components.

### **Avoid direct sun exposure on the eyepiece.**

Exposing the eyepiece to direct sunlight can damage the internal display.

### **Do not expose the instrument to extreme temperatures.**

TruPulse® 200X components are rated for a temperature range of -4 to +140° F (-20 to +60° C). Do not expose the instrument to temperatures outside this range whether in use or in storage.





## Section 1 - Introducing the LTI TruPulse 200X

Congratulations on the purchase of your TruPulse 200X, a cost-effective professional rangefinder. This compact and lightweight laser is a flexible tool for your measurement needs. The TruPulse includes six measurement modes and five target modes.

Features of the TruPulse:

- Crystal clear optics and the heads up display lets you keep your eye on the target.
- Bright red LED display dramatically improves visibility in all lighting conditions.
- The laser sensor and integrated tilt sensor measure slope distance and inclination. Values are automatically calculated for horizontal distance, vertical distance, height, and missing line.
- The Target Mode allows you to select or eliminate targets, which helps you take the most accurate measurement possible in a variety of field conditions.

### Operating Modes

#### Measurement Modes

Slope Distance  
Horizontal Distance  
Vertical Distance  
Inclination  
3-Point Height Routine  
2D Missing Line Routine

#### System Setup Mode

Brightness	Gate
Units	Baud Rate
Filter	Bluetooth
Targeting Modes	Firmware Version
Continuous	

### Unpacking Your TruPulse 200X

When you unpack your TruPulse 200X, check to make sure that you received everything that you ordered, and that it all arrived undamaged.

#### Basic Package

- TruPulse 200X
- Carrying Case
- Lens Cloth
- Neck Strap
- User's Manual
- Cr123A Battery
- Eyepiece Cover

#### Compatible Accessories

- Foliage Filter
- Tripod
- Mounting Brackets
- Download Cables

## Understanding How the TruPulse 200X Works

The TruPulse 200X consists of a laser range sensor, an integrated tilt sensor, and a digital processor. The TruPulse 200X has four buttons that access the unit's internal software, which controls the integrated sensors.

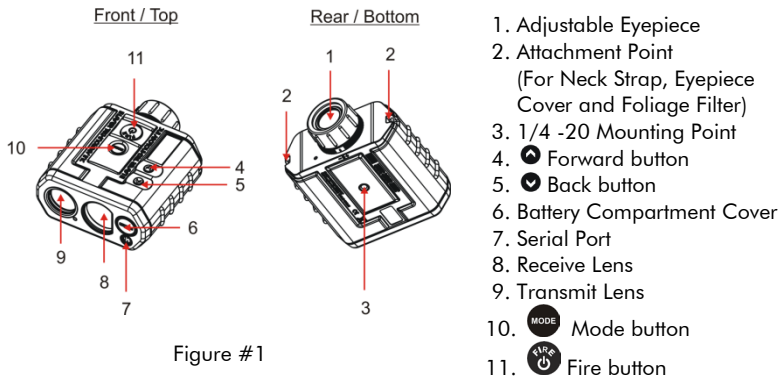



Figure #1

## Laser Range Sensor

The laser range sensor emits invisible, eye safe, pulses of infrared light energy. The TruPulse 200X determines distance by measuring the time it takes for each pulse to travel from the rangefinder to the target, and back. The  indicator is displayed whenever the laser is being transmitted. The laser may be active for a maximum of 10 seconds. The TruPulse 200X has a broad spectrum of sensitivity and can work with both reflective and non-reflective targets. See TruTargeting ([next page](#)) for information about high quality and low-quality targets.

## Targets

When selecting a target, you should consider the following:

- **Color:** The brighter the color, the longer the range.
- **Finish:** Shiny finishes provide longer range than dull finishes.
- **Angle:** Shooting perpendicular to a target provides better range than shooting to a target at a sharp angle.
- **Lighting Conditions:** Overcast skies will increase the unit's maximum range, and sunny skies will decrease the unit's maximum range.

## TruTargeting

The TruPulse 200X automatically provides the best accuracy and acquisition distance to a given target. Maximum measurement distance varies with target quality and environmental conditions. When shooting to a non-reflective (i.e., non-cooperative) target, the maximum measurement distance is 6,233 ft (1,900 m) typical. When shooting to a reflective (i.e., cooperative) target, the maximum measurement distance is 8,200 ft (2,500 m).

Target quality has an effect on the precision of measurements.

- High quality target: "c" is illuminated in the display (i.e., "cooperative" target) along with the measurement. Range accuracy:  $\pm 1.6$  inches ( $\pm 4$  cm) typical targets  $< 400$  m.  $\pm 6$  inches ( $\pm 15$  cm) accuracy to typical targets  $< 1000$  m.
- Low quality target: "c" is not illuminated in the display along with the measurement. Range accuracy:  $\pm 1.6$  inches ( $\pm 4$  cm) to  $\pm 1$  ft ( $\pm 30$  cm) to distant and weak targets\*.

\*Note: Target quality can be affected by atmospheric conditions, such as heat shimmer, dust, target reflectance, traverse angle to target and beam spread.

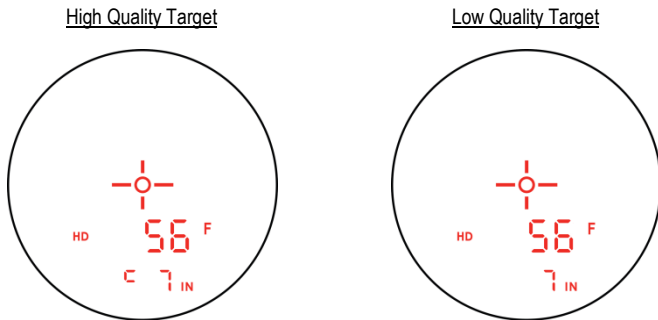





Figure #2

## Tilt Sensor

The integrated tilt sensor measures vertical angles that the TruPulse 200X uses to calculate height and elevation and to determine slope-reduced horizontal distances. The instrument held level is at  $0^\circ$ , and is rotated up through  $+90^\circ$  and down through  $-90^\circ$ .

- ① • The laser is not active in the Inclination Measurement Mode.
- Generally, the inclination is measured when you press . However, in (1) the Continuous Target Mode and (2) in the Height Measurement Mode, the inclination reading appears in the Main Display and the display updates as your aiming point changes as long as you press . In these two situations, the measured inclination is based upon the aiming point when you release .

## Section 2 - Quick Start











1. Install the battery (page 10).
2. Press  to power ON the TruPulse 200X.
3. Select a target such as a wall across the room or a nearby tree. For this example, the target should be approximately 10 meters (33 feet or 11 yards) from you.
4. Look through the eyepiece (see Figure #3) and use the crosshair to aim to the target. The in-scope LED should look similar to Figure #4A.



Figure #3

- If the HD indicator is not displayed, press  or  until the HD indicator is displayed.
5. Press-and-hold . The laser indicator  is displayed and flashes while the laser is active (Figure #4B). The laser will remain active for a maximum of 10 seconds while acquiring data about the target.
    - If the target is not acquired, release  and repeat this step. [www.a](http://www.a)
  6. Release  once the distance is displayed (Figure #4C). The measurement will be displayed steady until you press a button or the unit powers OFF.

- Press  or  to scroll through the measurement modes and see the results acquired for each function.
- Repeat steps #3-#6 above to take another measurement.
- Simultaneously press-and-hold  and  for 4 seconds to power OFF the TruPulse 200X.

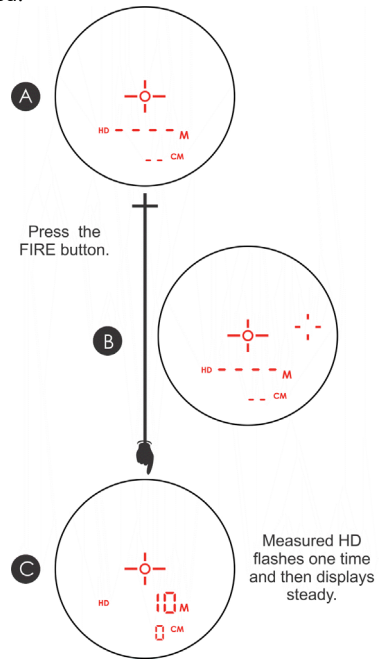

Figure #4

## Section 3 - Basic Operations

### Installation

The TruPulse 200X is powered by a 3 Volt Lithium battery commonly referred to as CR123A or also referred to as CR123. The battery is located in the Battery Compartment at the front of the instrument.

1. Remove the Battery Compartment Cover by lifting up the Hinged Tab and turning counterclockwise,
2. Insert the battery negative end (-) first.
3. Re-insert the Battery Compartment Cover and use the Hinged Tab to turn clockwise.
4. Press down on the Hinged Tab to secure.

① Note: To remove the battery, just reverse the above instructions

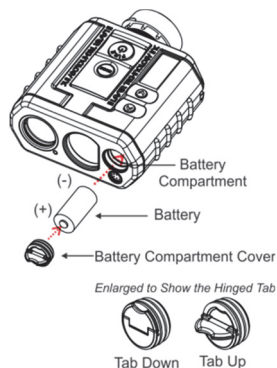





Figure #5

### Battery Voltage Level

The TruPulse 200X continuously monitors its power source. LTI has defined an acceptable voltage range to ensure that the instrument has sufficient battery voltage to guarantee correct operation.

Battery Icon Appearance	Explanation
Battery icon not displayed	Battery is equal to or greater than 2.4 V.
	Battery is greater than 2.1 V and less than 2.4 V.
	Battery is greater than 2.0 V and less than 2.1 V.
	Battery is below 2.0 V. The TruPulse 200X will automatically power off.

## Buttons

The TruPulse 200X has a 4-button keypad located on the top panel of the instrument. The buttons provide easy access to the instrument functions. This manual refers to the buttons while the laser is oriented as shown in Figure #6. The table below lists the buttons and the function of each.



Figure #6



<b>Measurement Modes</b>	Powers ON the unit. Distance Measurement: fires the laser. Inclination: Release “locks” tilt sensor in (1) Height Measurement Mode and (2) Continuous Target Mode.
<b>Height Routine</b>	(HD) Fires the laser. (INC) Release “locks” tilt sensor.
<b>System Setup Mode</b>	Selects option and returns to the Measurement Mode.



<b>Measurement Modes</b>	Displays the System Setup Mode.
<b>System Setup Mode</b>	Press to scroll to the next System Setup option.





<b>Measurement Modes</b>	Press to scroll to the previous Measurement Mode.
<b>Height Routine</b>	Clears the last measurement and re-displays the previous prompt.
<b>System Setup Mode</b>	Press to scroll to the previous option.



<b>Measurement Modes</b>	Press to scroll to the next Measurement Mode.
<b>Height Routine</b>	Exits the Height Routine.
<b>System Setup Mode</b>	Press to scroll to the next option.

## Powering OFF the TruPulse 200X

Press  and  buttons at the same time to manually power off the unit. To conserve battery power, the TruPulse 200X powers itself OFF if no button presses are detected after a specified length of time:

- Bluetooth OFF: 2 minutes
- Bluetooth ON: 30 minutes

## Display Indicators











Figure #7 shows the LED in-scope display. The TruPulse 200X's internal software is organized into options. Each option represents a specific measurement or setup function and has a corresponding display indicator. Refer to Figure #7 and the table below for information about each indicator.





Figure #7

	<b>Main Display</b>	Displays messages and measurement results.
	<b>Lower Display</b>	Displays messages and measurement results.
	<b>Setup Mode</b>	Displayed when the System Setup Mode is active.
	<b>Degrees</b>	Inclination measurement units.
	<b>Feet</b>	Distance measurement units. Selection available in the System Setup Mode.
	<b>Meters</b>	
	<b>Yards</b>	
	<b>Centimeters</b>	
	<b>Inches</b>	
	<b>Battery Status</b>	See <a href="#">Page 10</a> .
	<b>Crosshair</b>	Serves as the aiming point reference, both horizontally and vertically.
	<b>Laser Status</b>	<i>Visible and Flashing:</i> Laser is firing. <i>Visible and Steady:</i> Target is acquired. <i>Not Visible:</i> Laser is not active.





	<p><b>Continuous Target Mode</b></p>	<p>The unit continuously acquires targets and displays measurements while  is held down. The distance to the most recently acquired target is displayed.</p>
<p><b>INC</b></p>	<p><b>Inclination Measurement Mode</b></p>	<p>The angle of inclination between the TruPulse 200X and the target.</p>
<p><b>SD</b></p>	<p><b>Slope Distance Measurement Mode</b></p>	<p>Straight line distance between the TruPulse 200X and the target.</p>
<p><b>HD</b></p>	<p><b>Horizontal Distance Measurement Mode</b></p>	<p>Slope-corrected distance between the TruPulse 200X and the target, projected in the horizontal (XY) plane; a.k.a. Run.</p>
<p><b>VD</b></p>	<p><b>Vertical Distance Measurement Mode</b></p>	<p>Slope-corrected distance between the TruPulse 200X and the target, projected in the vertical (Z) plane; a.k.a. Rise.</p>
<p><b>ML</b></p>	<p><b>Missing Line Measurement Routine</b></p>	<p>Two-step Missing Line Routine finds the connecting vector (or missing line) between two points.</p>
<p><b>HT</b></p>	<p><b>Height Measurement Routine</b></p>	<p>Three-step height routine. The final calculation represents the vertical distance between the points on the target represented by ANG1 and ANG2.</p>
	<p><b>Closest Target Mode</b></p>	<p>The unit logs multiple targets while  is held down. The  denotes that additional targets have been acquired. Of the targets acquired, the distance to the closest target displays.</p>
	<p><b>Farthest Target Mode</b></p>	<p>The unit logs multiple targets while  is held down. The  denotes that additional targets have been acquired. Of the targets acquired, the distance to the farthest target displays.</p>
	<p><b>Gate Mode</b></p>	<p>The unit will only acquire targets beyond the user-selected gate value.</p>
	<p><b>Filter Mode</b></p>	<p>Similar to Standard, single shot mode, but the laser's sensitivity is reduced so it only detects pulses returned from a reflector. The optional foliage filter is used in conjunction with this mode.</p>

	<p><i>Although the TruPulse 200X does not use these indicators, they do appear during the Display Indicator Test.</i></p>
	
<b>MOA</b>	
<b>AZ</b>	

## Display Indicator Test

To verify that all display indicators are working properly:

1. Start with the TruPulse 200X powered OFF, press-and-hold .
2. Compare the in-scope display to the Figure #7 (Page 12) to verify that all indicators are working properly.
3. Release  to start normal operation.

## Error Codes

Error conditions can occur in a measurement or in the system hardware. To make sure that you never get an erroneous measurement, the TruPulse 200X monitors both system hardware and measurements. Error codes appear in the main display and are in the form of "E xx", where "xx" is an error code number. Figure #8 shows an example error code, E 01.

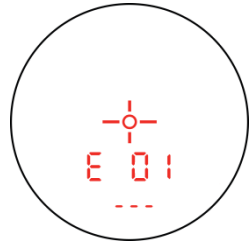



Figure #8

Error Code	Explanation
E 01	Failure to lock on target. Reposition instrument and retake the measurement. If you continue to receive the error, the target maybe out of range or have no reflective qualities.
E 50 or above	Shut off unit and try again. If the same error repeats, please contact LTI Service Department

① If an error code persists:

1. Release  and press again to try to retake the measurement.
2. Remove and re-install the battery and then try to retake the measurement.
3. If the above steps do not resolve the error, contact LTI or an Authorized LTI Distributor for assistance. Refer to the inside front cover for LTI contact information.

## Eyepiece

The eyepiece is located at the back of the TruPulse 200X. It includes a 7X magnification scope.

- ① **Eyepiece Cover:**  
The eyepiece cover protects the internal components from sunlight exposure. The eyepiece cover should be in place whenever the TruPulse 200X is not in use.

To attach the eyepiece cover:  
Feed the thin cord under the metal bar and flare the loop open. Pull the eyepiece cover through the loop. Gently tighten to secure.

## Focus Adjustment Ring

The Focus Adjustment Ring allows you to focus the LED in-scope display. During assembly, optimum focus is set to infinity. To adjust the LED focus, turn the Focus Adjustment Ring to suit your personal preference. See Figure #9.

- ① Monocular adjustment reduces eye fatigue.

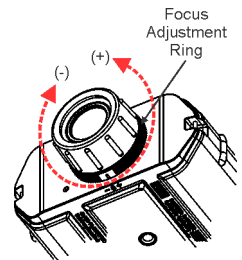

Figure #9

## Foliage Filter

The TruPulse's Filter Targeting Mode allows the TruPulse accurately penetrate heavy foliage. The laser's sensitivity is reduced so the laser only detects pulses returned from a reflective target. This means that the TruPulse will reject pulses from a non-reflective target. The Foliage Filter must be used in conjunction with the Filter Target Mode.

1. Attach the Foliage Filter to the TruPulse 200X:
  - a. Feed the loop of the Tether around the metal post of either attachment point.
  - b. Feed the Foliage Filter through the loop.
  - c. Gently tighten to secure.
2. Place the Foliage Filter over the TruPulse's Receive Lens. Figure #10 shows the Receive Lens.
3. Align the Receive Lens Filter. To fit properly, align the straight edge of the filter with the straight edge of the lens.
4. Press the Foliage Filter all the way into the lens cavity.

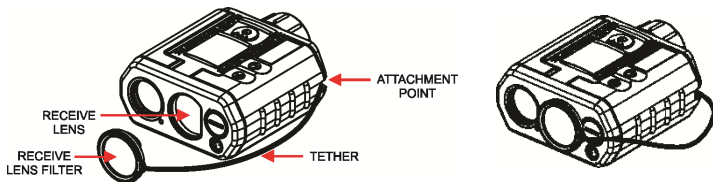

Figure #10

- ① See [Page 24](#) for information about using the Filter Targeting Mode.

## Measurement Point of Reference

The measuring point of the TruPulse 200X is located at the center point of the instrument, the 1/4-20 thread.

## Neck Strap

1. Find the two Attachment Points located on the rear panel of the TruPulse 200X.
2. Insert the end of one of the connector straps into one side of the eyelet opening and feed it through to the other side.
3. Feed the strap up from the bottom of the buckle, then over the center of the buckle and back down through the other side.
4. Pull the strap to take up any slack and tighten the strap to simply have a loop that is fed through the eyelet.
5. Repeat steps 2-4 to attach the other connector strap to the other side of the TruPulse 200X.
6. Attach one end of the neck strap into the side release buckle of one of the connector straps.
7. Attach the other end of the neck strap to the side release buckle of the other connector strap.

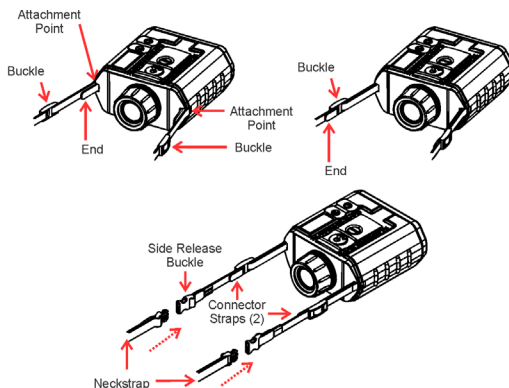

Figure #11

- ①
  - Make sure the strap is straight when attaching it to the TruPulse 200X. This will help you avoid uncomfortable twists in the strap that will rub your neck.
  - Before use, check to make sure the neck strap is secure. Failure to do so may result in the TruPulse 200X hitting the ground or other object.
  - The neck strap may also be attached to the carrying case.

## Serial Port

The TruPulse 200X includes a serial port located on the front panel and allows the instrument to download measurement data. See [Page 42](#) for more information on the serial data interface.





## Restore Default Settings

It is possible to restore the TruPulse 200X's default settings. Restoring the default settings, affects some of the system setup options.

The table below lists the parameters and the associated default settings. The third column lists the page reference for additional information.

Parameter	Default Value	Refer to Page Number
Measurement Mode	HD	<a href="#">32</a>
LED Brightness	br03	<a href="#">20</a>
Distance Units	Meters and cm	<a href="#">21</a>
Filter Mode	off	<a href="#">22</a>
Targeting Mode	Std	<a href="#">24</a>
Continuous Mode	off	<a href="#">23</a>
Gate	off	<a href="#">26</a>
Baud Rate	4800	<a href="#">28</a>
Bluetooth	off	<a href="#">29</a>

To restore the default settings:





1. Simultaneously press-and-hold the , , and  buttons for approximately 5 seconds. The instrument will power off.
2. Press  to power ON the unit.

## Section 4 – System Setup Mode

The System Setup Mode can be accessed from the Measurement Mode at any time by pressing . To view each option, press . To exit System Setup press . Each option is described separately in the following sections.

- Brightness
- Units
- Filter
- Targeting Modes
- Continuous
- Gate
- Baud Rate
- Bluetooth
- Firmware Version

### Brightness

1. Press .
2. Short press  until the desired setting is achieved. It's easy to get the desired setting if you look through the eyepiece while making the adjustment.
  - The LED in-scope display has five intensity settings from DIM (1) to BRIGHT (5).
  - Each time you press , the "brxx" value increases by 1.
  - If you press the button while "br05" is displayed, you will see "br01" next.
3. Press  to accept the brightness level and return to the Measurement screen.

- ① Each time the TruPulse 200X is powered ON, it will return to the same brightness setting that was last used.

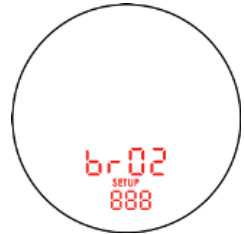

Figure #12



## Units of Measure









1. Press  until the Unit option is displayed.
  2. Press  or  to display the previous or next unit option.
    - Meters / Centimeters and Degrees
    - Meters / Centimeters and Percent Slope
    - Feet / Inches and Degrees
    - Feet / Inches and Percent Slope
    - Yards and Degrees
    - Yards and Percent Slope
  3. Press  to accept the units of measurement and return to the Measurement screen.
- ① Each time the TruPulse 200X is powered ON, it will return to the same unit setting that was last used.



Figure #13

## Filter Mode

In this mode, the laser's sensitivity is reduced to only detect pulses returned from a reflector. The optional foliage filter is used in conjunction with this mode.

1. Press  until the FILt option is displayed.
2. Press  or  to display the previous or next Filter Mode option.
  - oFF
  - on
3. Press  to accept the Filter Mode option and return to the Measurement screen.

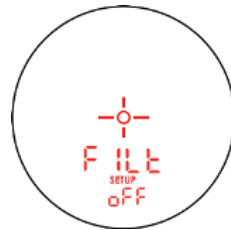







Figure #14

- If "on", the Filter Mode indicator  is illuminated and the electronic filter is applied. The Foliage Filter must also be used for proper target discrimination.
  - Typical maximum distance is 107 meters (350 feet) to a 7.5 cm (3 inch) prism.
- ①
- Each time the TruPulse 200X is powered ON, it will return to the same Filter Mode setting that was last used.
  - When Filter Mode is "on" and the Foliage Filter is in place, the laser's sensitivity is reduced so the laser only detects pulses returned from a reflective target. This means that the TruPulse will reject pulses from a non-reflective target.

## Continuous Mode

In this mode, once the target is acquired, the TruPulse 200X can continuously acquire additional targets until  is released. When  is released, the most recently acquired target appears in the Main Display.

1. Press  until the Con option is displayed.
2. Press  or  to display the previous or next Continuous Mode option.
  - off
  - on

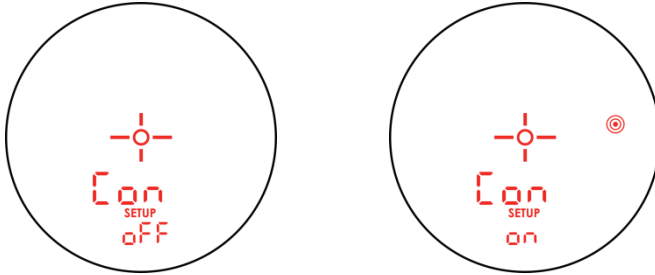







Figure #15

3. Press  to accept the Continuous Mode option and return to the Measurement screen.
    - If “on”, the Continuous Mode indicator  will be illuminated.
- ① Each time the TruPulse 200X is powered ON, it will return to the same Continuous Mode setting that was last used.

## Targeting Modes

1. Press  until the tArg option is displayed.
2. Press  or  to display the previous or next Targeting Mode option.

- Std: Standard single shot mode
- FAr: Farthest Mode

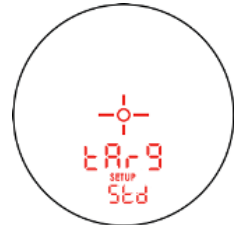



Figure #16

The  indicator is illuminated when this mode is active. Once the initial target is acquired, the TruPulse can acquire additional targets. The  indicator denotes that multiple targets have been acquired. The farthest acquired target always appears in the Main Display.

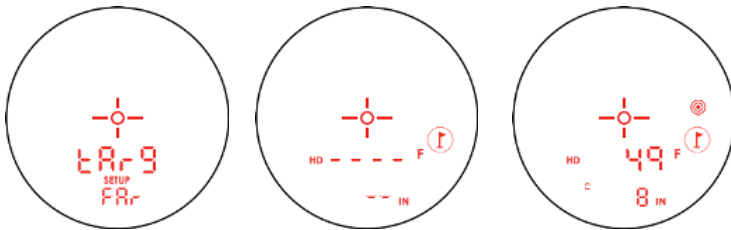



Figure #17

- Clo: Closest Mode

The  indicator will be illuminated when this mode is active. Once the initial target is acquired, the TruPulse can acquire multiple targets. The  indicator denotes that multiple targets have been acquired. The closest acquired target always appears in the Main Display.

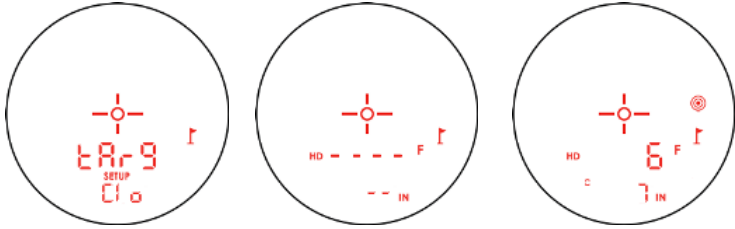







Figure #18

3. Press  to accept the Target Mode option and return to the Measurement screen.
- ① Each time the TruPulse 200X is powered ON, it will return to the same Targeting Mode setting that was last used.

## Gate

In this mode, the TruPulse 200X will only acquire targets beyond the selected gate value.

1. Press  until the gAtE option is displayed.
2. Press  or  to display the previous or next Gate option.
  - oFF
  - on : When the Gate option is on, the gate indicator  is illuminated.

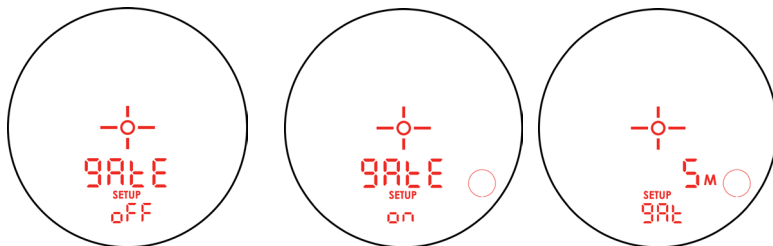















Figure #19

3. Press  to change the value. Press and release  to increase value by increments of 1.
  1. After 4 seconds of holding down , it will speed up in increments of 1.
4. Stop at the required Gate value.
  1. If you go past the required value, press  to decrease the value by increments of 1.
  2. After 1 second of holding down , the value will slowly auto increase by increments of 1.
  3. After 4 seconds of holding down , it will speed up by increments of 1.
5. Press  to accept the gate value, the main screen will have the Gate icon illuminated.

### To Change the Gate Value:



1. Press  until you see "gAtE".
2. Press  again. The value now can be updated (see #4 above).

### To Turn Off the Gate Function:

1. Press  until the gAtE option is displayed.
  2. Press  or  to change from On to Off.
  3. Press  twice to return to measurement display.
- 
- ①
- Minimum Gate Value: 1 meter, 4 feet or 2 yards
  - Maximum Gate Value: 500 meters, 1640 feet or 500 yards
  - If gate value is less than 1 meter, 4 feet or 2 yards, it will be treated as NO GATE.
  - Each time the TruPulse 200X is powered ON, it will return to the same Gate setting that was last used.

## Baud Rate

The Baud Output Rate is the speed that data is transmitted, and it is a derived value based on the number of symbols transmitted per second.

1. Short press  until the bAud option is displayed.
2. Press  or  to display the previous or next Baud Output Rate option.
  - 480 = 4800
  - 960 = 9600
  - 192 = 19200
  - 384 = 38400
  - 576 = 57600
  - 115 = 115200

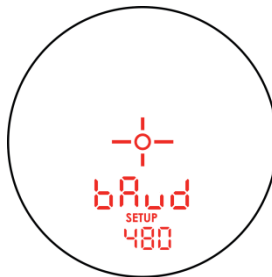



Figure #20





3. Press  to accept the Baud Output Rate option and return to the Measurement screen.
- ① Each time the TruPulse 200X is powered ON, it will return to the same Baud Output Rate setting that was last used.



## Bluetooth

Bluetooth wireless technology is an industry standard specification for short-range wireless connectivity. As a short-range radio link, Bluetooth replaces cable connections between devices allowing you to download measurement data to any Bluetooth enabled PC device such as a laptop PC, data collector, etc.

- TruPulse Bluetooth offers serial port service to connect to an RS-232 style serial connection. It replaces the download cable from the TruPulse 200X to any Bluetooth enabled PC device.
- TruPulse Bluetooth is a slave device. Bluetooth master devices can detect the TruPulse 200X when the instrument is powered ON and the Bluetooth option is enabled.

1. Short press  until the bt option is displayed.
2. Press  or  to display the previous or next bt option.
3. Press  to accept the blue tooth option and return to the Measurement Mode display.

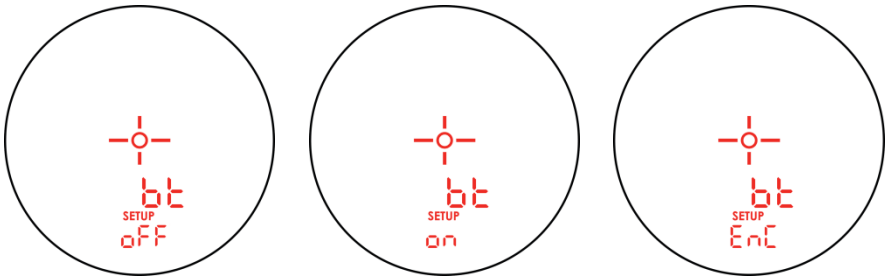

Figure #21

- off: Turns the Bluetooth communications off.
- on: Turns the Bluetooth communications on. Serial string is outputted through the Bluetooth and serial port.
- EnC: Bluetooth Copy Mode. This mode is reserved for future use with the MapStar TruAngle.

- ①
  - Each time the TruPulse 200X is powered ON, it will return to the same Bluetooth setting that was last used.
  - Bluetooth Version 2.0 Class 2.1 + EDR module.

Refer to the instructions below when connecting your TruPulse 200X to another Bluetooth device. This information is provided as a general guideline.

- ① Refer to the third-party product documentation for your specific Bluetooth device.
1. Toggle the TruPulse Bluetooth option ON and return to the measurement mode. A host device can now detect the Bluetooth communication from the TruPulse 200X.
    - Refer to the host device documentation for connecting to Bluetooth devices.
  2. Use the Bluetooth Manager to scan for the TruPulse Bluetooth module. The TruPulse Bluetooth will be named TP200X -"serial number of unit"; ie TP200X-200003.
  4. You may be prompted to enter:
    - Passkey = 1234
    - Service Selection = SPP Slave
    - Select (long press) "Connect". The Bluetooth Manager on the host device should find and display the active connection status.
- ① Bluetooth troubleshooting tips:
    - TruPulse: Verify that the TruPulse Bluetooth option is toggled ON.
    - Bluetooth enabled PC device: Verify that the Bluetooth connection is active.
    - Verify that the Bluetooth device is physically located within the wireless transmission range of the TruPulse 200X. Transmission range can vary depending upon (1) position relative to the TruPulse or (2) type of Bluetooth connection.

## Firmware Revision Number

1. Short press  until the Firmware Revision option is displayed. In Figure #22, the firmware revision number is 1459.

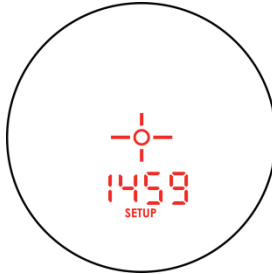



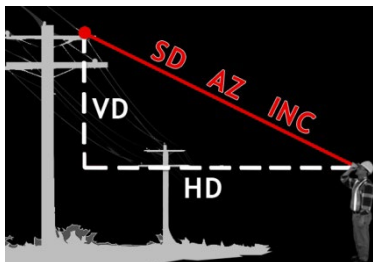

Figure #22

2. Press  to return to the Measurement screen.
- ① LTI Technical Support may require this information when troubleshooting a problem.

## Section 5 - Measurement Modes

When you power ON the TruPulse 200X, the last used Measurement Mode will be active. Press  or  to display the previous or next Measurement Mode. Figure #23 shows the six different types of measurements that the TruPulse 200X can take. For information about the Missing Line Routine, see [Page 39](#).







- ❶ SD Slope Distance
- ❷ INC Inclination INC
- ❸ HD Horizontal Distance
- ❹ VD Vertical Distance
- ❺ HT Height Routine
- ❻ ML Missing Line Routine

 = Measured  
 = Calculated



Figure #23





### Distance Measurements

The basic steps for taking any distance measurement:



1. Look through the eyepiece and use the crosshair to aim to the target.
2. Press-and-hold . The laser indicator  is displayed while the laser is active. The laser will remain active for a maximum of 10 seconds while acquiring data about the target.
  - If the target is not acquired in the 10 second period, release  and repeat this step.
3. Once the measurement is displayed, release . The measurement will be displayed steady until you press any button or the unit powers OFF.

## Notes about Measurements

- ① Press  or  to scroll through the individual measurement functions and see the results acquired for each function.
- Both inclination and distance are measured in the Horizontal Distance, Slope Distance, and Vertical Distance modes.
  - Example Range Measurement:

	HD = 12.5 meters
	VD = 1.6 meters
	SD = 12.6 meters
	INC = 7.3 degrees
  - When you scroll to the Height Function, the Main Display will be blank, and the HD will be flashing.
  - In the Inclination Mode, the Main Display will be blank for all other measurement functions since the laser is not active when measuring inclination only.
  - The last measurement does not need to be cleared before acquiring your next target.
  - Each time the TruPulse 200X is powered ON, it will return to the same measurement mode that was last used.

## Inclination Measurements

The laser is not active in the Inclination Measurement Mode. Generally, the inclination is measured when you press . However, in (1) the Continuous Target Mode and (2) in the Height Measurement Mode, the inclination reading appears in the Main Display and the display updates as your aiming point changes as long as you press .

## Percent Slope

Percent slope (indicated by Per) is a calculation equal to 100 times the tangent of the inclination angle. It is a variant way of expressing the inclination. You can get percent slopes only in the basic measurement displays, never in the Height measurement displays. Note also that the instrument never downloads a percent slope. It always downloads the inclination angle.

- ① An inclination angle of 5 degrees for example is equal to a slope of about 8.75 percent.

## Height Routine

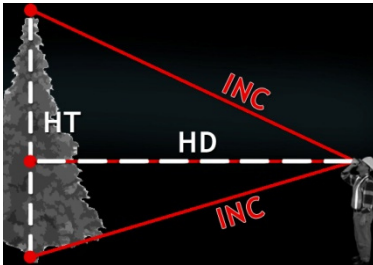

Height Measurements involve a simple routine that prompts you to take 3 shots to the target: Horizontal Distance, Inclination Angle base and Inclination Angle top. The TruPulse 200X uses these results to calculate the height of the target. Figure #24 shows the shots required for the height routine.



Shot 1: HD  
Shot 2: INC to base  
Shot 3: INC to top

 = Measured  
 = Calculated

Figure #24

1. Short press  or  to scroll until the main display looks similar to Figure #25.

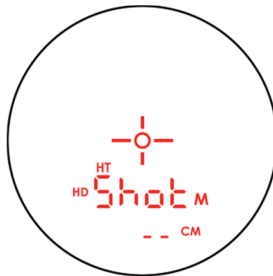



Figure #25

2. Select your target and look through the eyepiece, using the crosshair to aim to your target. The HT and HD indicators and the word "Shot" will appear in the display. This is prompting you to measure the Horizontal Distance to the "face" of the target.
3. Press-and-hold . The laser indicator  is displayed while the laser is active. The laser will remain active for a maximum of 10 seconds while acquiring data about the target. The measured horizontal distance appears briefly in the Main Display and then HT, An\_1 and the inclination value area (degree symbol) is displayed. This is prompting you to measure the inclination to base (or top) of the target.

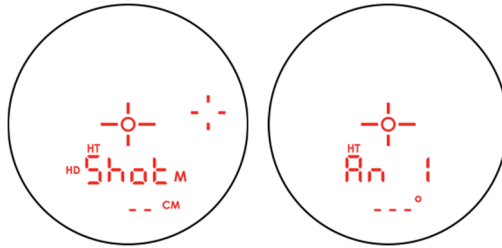

Figure #26







4. Press-and-hold  and aim to the base (or top) of the target. The measured inclination appears in the Main Display and is updated as long as us you continue to hold . The measured inclination is "locked" when you release . The measured inclination appears briefly in the Main Display and then Ang\_2 appears and the INC indicator flashes; prompting you to measure the inclination to the top (or base) of the target.



Figure #27



1. Press-and-hold  and aim to the top (or base) of the target. The measured inclination appears in the Main Display and is updated as long as you continue to hold . The measured inclination is “locked” when you release . The measured inclination appears briefly in the Main Display and then the calculated Height is displayed steady until you press any button or the unit powers OFF.

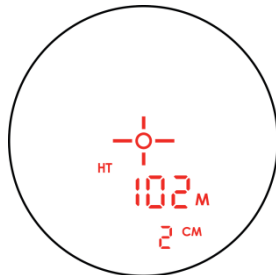





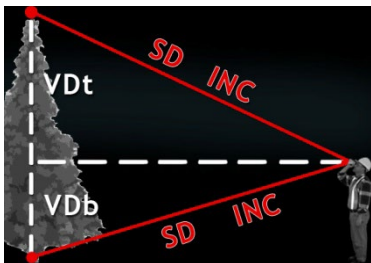

Figure #28

- ① During the height routine:
  - Press  or  to re-shoot the previous point.
  - The laser is not active while measuring the ANG1 and ANG2 values. As long as you hold , the inclination reading is displayed and updated as your aiming point changes. The measured inclination is based upon your aiming point when you release .
  - When the height result is displayed, just press  to start the routine and repeat the steps.

## 2-Step Height Routine

This method is best for measuring trees where the top is generally not directly over the base. However, you do have to have a clear line of sight to the top and the base to measure distance and inclination there.



Shot 1: INC to top  
Shot 2: INC to base

 = Measured  
 = Calculated

Figure #29

1. Scroll to the VD Measurement Mode
  2. Shoot to the top of the object. You may need to reshoot to make sure you're getting the highest point. Record this value as VDt.
  3. Without moving your location at all, shoot to the base of the object and record this value as VDb (it may be a negative value).
  4. The resulting Height value is  $VDt - VDb$ .
- ① The 2D Missing Line Routine may be used for this also. The resulting Missing Line Vertical Distance value will be the Height of the object. See next section for information about the 2D Missing Line Routine.

## 2D Missing Line Routine

The 2D Missing Line Routine calculates distances and angles to describe the relationship between two points in two-dimensional space (connecting vector). This routine is ideal for remote slope determinations and changes in elevation from one location.

The simple routine prompts you to take two shots to targets: "Shot 1" and "Shot 2". The TruPulse uses the results to calculate four variables between the two points: slope distance, inclination, horizontal distance, and vertical distance as shown in figure below.

- Horizontal Distance: Horizontal component of the missing line.
- Vertical Distance: Change in elevation between point #1 and point #2.
- Slope Distance: Length of the missing line.
- Inclination between point #1 and point #2.

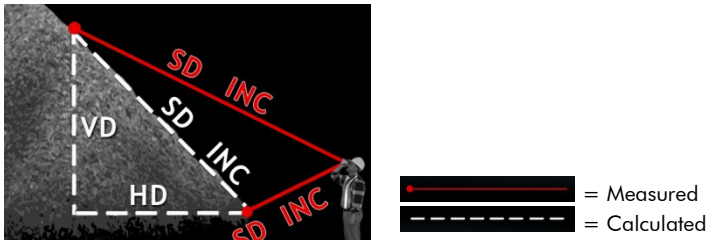





Figure #30

If you were to actually stand at the location of shot 1 and take a measurement to shot 2, the calculated values would be from shot 1 to shot 2. If the first shot is farther away and higher than the second shot, the measurement values: HD, SD will be positive values and INC, VD will be negative values. If the first shot is closer than second shot, the measurement values: HD, SD, INC, VD will be positive values.

1. Short press  or  to scroll until the main display looks similar to Figure #31.

During the 2D Missing Line Routine:

- Press  to re-shoot Shot 1.
- Press  to exit the Missing Line Routine.

2. Select your first target and look through the eyepiece, using the crosshair to aim at your target for the first point. The main display will have the ML and HD indicators and the word "Sh 1". This is prompting you to measure the Horizontal Distance to the face of the target

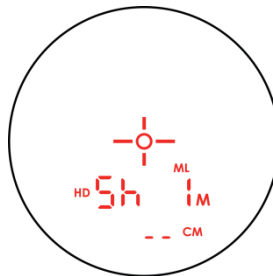





Figure #31

3. Press-and-hold . The laser status indicator  is displayed while the laser is active. The laser remains active for a maximum of 10 seconds while acquiring data about the target. The measured horizontal distance appears briefly in the Main Display.

4. The Main display will now prompt you for the second shot and will look similar to Figure #32. Looking through the eyepiece and using the crosshair

to aim to the second target. Press-and-hold , the Laser status indicator  is displayed while the laser is active. The laser remains active for a maximum of 10 seconds while acquiring data about the target.

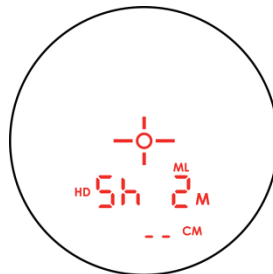

Figure #32

Once the 2nd target is acquired, the Missing Line Vertical Distance results are displayed.

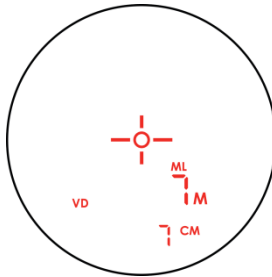





Figure #33

At this time, you can:

- Press  or  to scroll and see the other missing line measurements results (HD, SD, and INC).
- Press  twice to exit the missing line results and return to Shot 1.

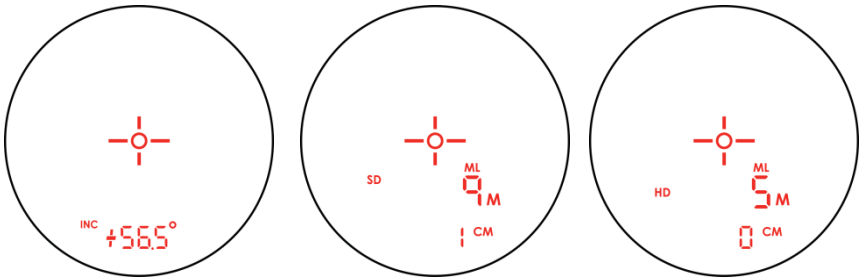

Figure #34

## Section 6 – Serial Interface

The TruPulse 200X includes a hard-wired serial (RS-232) communication port and wireless Bluetooth communication is also available. In either case, the measurement data downloaded from the TruPulse is in ASCII Hex format, and duplicates LTI's Criterion 400 (CR400) communication protocol and download messages.

### Format Parameters

4800 baud, 8 data bits no parity, 1 stop bit

### Serial Port

Figure #35 shows the pin-out assignments for TruPulse 200X's serial port.

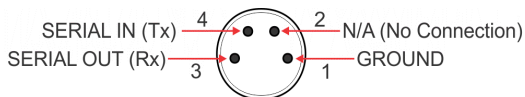

Figure #35

### Download Message Format

The CR400 data format follows the guidelines of the NMEA Standard for interfacing Marine Electronic Navigational Devices, Revision 2.0. NMEA 0183 provides for both standard and proprietary data formats. Since none of the standard formats are useful for the data transferred from the TruPulse 200X, special proprietary formats are used. Rules described in the NMEA standard governing general message structure, leading and trailing characters, numeric values, delimiting character, checksums, maximum line length, data rate, and bit format are followed exactly. As required by NMEA 0183, the CR400-format does not respond to unrecognized header formats, malformed messages, or messages with invalid checksums.

## Requests

The TruPulse 200X accepts Criterion 400 format requests for the firmware version ID. The instrument will not respond to an invalid query. The format is as follows:

### Firmware Version ID Request (1)

**\$PLTIT,RQ,ID<CR><LF>**

**\$PLTIT** The Criterion 400 message identifier.  
**RQ** Indicates a request message.  
**ID** Indicates the request type.  
**<CR>** Carriage return.  
**<LF>** Optional linefeed.

Instrument response:

**\$PLTIT,ID,model,versionid \*csum<CR><LF>**

**\$PLTIT** The Criterion 400 message identifier  
**ID** Identifies the message type.  
**model** Indicates the model.  
**versionid** The main firmware revision number.  
**\*csum** An asterisk followed by a hexadecimal checksum.  
The checksum is calculated by XORing all the characters between the dollar sign and the asterisk.  
**<CR>** Carriage return.  
**<LF>** Linefeed.

Examples:

Request: \$PLTIT,RQ,ID

Response: \$ID,TP-100,TruPulse200X-3.14-53,FEB 21 2013,AD9829CF\*4FCF

## Firmware Version ID Request (2)

**\$ID<CR><LF>**

- \$ID** The request identifier
- <CR>** A carriage return.
- <LF>** An optional line feed character.

Instrument response:

**\$ID,<model>,<Product name>-<version>-<build number>,Build date,\*csum<CR><LF>**

- \$ID** Message identifier.
- TPmodel** The TruPulse model (TP-100).
- versionid** The version ID of the internal firmware (preceded by a hyphen).
- Date** The effective date of the firmware version.
- Csum** 32-bit firmware checksum.
- \*csum** CRC16 checksum of the data string up to the asterisk.

Examples:

Request: \$ID<CR><LF>

Response: \$ID,TP-100,TruPulse200X-3.14-61,JUN 21 2013,8E506B74\*A1CF

## Serial Number Request

**\$SN<CR><LF>**

- \$SN** The request identifier.
- <CR>** A carriage return.
- <LF>** An optional line feed character.

Instrument Response:

**\$SN,SerialNum\*csum<CR><LF>**

- \$SN** Message identifier.
- SerialNum** TP followed by 6 digit serial number.
- \*csum** CRC16 checksum.
- <CR>** A carriage return.
- <LF>** An optional line feed character.

Examples:

Request: \$SN<CR><LF>

Response: \$SN,TP200014\*31AA



### Remote Trigger (RUN) Request

**\$GO<sub>,n</sub><CR><LF>**

\$GO The request identifier.

*n* Number of iteration.

If number of iterations is omitted, it executes same as previous run.

<CR> A carriage return.

<LF> An optional line feed character.

### Instrument Response:

**\$OK\**csum*<CR><LF>**

\$OK Message identifier.

\**csum* CRC16 checksum of data string up to the asterisk.

### Examples:

\$GO,0 Continuous measurements

\$GO,3 3 measurements

### Remote Trigger (STOP) Request

**\$ST<CR><LF>**

\$ST The request identifier.

<CR> A carriage return.

<LF> An optional line feed character.

### Instrument Response:

**\$OK\**csum*<CR><LF>**

\$OK Message identifier.

\**csum* CRC16 checksum of data string up to the asterisk.

### Examples:

Request: \$ST<CR><LF>

Response: \$OK\*0744

## Download Message Formats

### Horizontal Vector (HV) Download Messages

**\$PLTIT,HV,HDvalue,units,AZvalue,units,INCvalue,units,SDvalue,units,\*csum<CR><LF>**  
where:

<b>\$PLTIT,</b>	is the Criterion message identifier.
<b>HV,</b>	Horizontal Vector message type.
<b>HDvalue,</b> units,	Calculated Horizontal Distance. Two decimal places. F=feet Y=yards M=meters
<b>AZvalue,</b> units,	Azimuth dummy value (always 0.00). D=degrees
<b>INCvalue, Measured</b> units,	Inclination value. Two decimal places. May be positive or negative value. D=degrees
<b>SDvalue,</b> units,	Measured Slope Distance Value. Two decimal places. F=feet Y=yards M=meters
<b>*csum</b>	An asterisk followed by a hexadecimal checksum. The checksum is calculated by XORing all the characters between the dollar sign and the asterisk.
<b>&lt;CR&gt;</b>	Carriage return.
<b>&lt;LF&gt;</b>	Optional linefeed.

- ① Closest and Farthest Target Modes: multiple targets can be acquired, however, the download message corresponds to the value that appears in the Main Display.

### Examples:

Horizontal Vector: \$PLTIT,HV,48.65,F,,, -1.50,D,48.67,F\*16  
Inclination Only: \$PLTIT,AG,-3.85,D\*06

## Height (HT) Download Messages

**\$PLTIT,HT,HTvalue,units,\*csum<CR><LF>**

where:

<b>\$PLTIT,</b>	is the Criterion message identifier.
<b>HT,</b>	Height message type.
<b>HTvalue,</b> units,	Calculated Height. Two decimal places. F=feet Y=yards M=meters
<b>*csum</b>	An asterisk followed by a hexadecimal checksum. The checksum is calculated by XORing all the characters between the dollar sign and the asterisk.
<b>&lt;CR&gt;</b>	Carriage return.
<b>&lt;LF&gt;</b>	Optional linefeed.

Example:

**\$PLTIT,HT,22.10,F\*0C**

## Missing Line (ML) Download Messages

For "Sh 1" and "Sh 2" refer to Horizontal Vector (HV) Download Message ([Page 46](#)).

\$PLTIT,ML,HD,HDunits,AZ,AZunits,INC,INCunits,SD,SDunits\*csum<CR><LF>

\$PLTIT,	is the Criterion message identifier.
ML,	Missing Line message type.
HD,	Specifies horizontal distance measurement value.
HDunits,	Specifies horizontal distance units. F=feet, M=meters, Y=yards.
AZ,	Specifies azimuth measurement value.
AZunits,	Specifies azimuth units. D=degrees.
INC,	Specifies inclination measurement value.
INCunits,	Specifies inclination units. D=degrees.
SD,	Specifies slope distance measurement value.
SDunits	Specifies slope distance units. F=feet, M=meters, Y=yards.
*csum	An asterisk followed by a hexadecimal checksum. The checksum is calculated by XORing all the characters between the dollar sign and the asterisk.
<CR>	Carriage return.
<LF>	Line feed.

Example:

```
$PLTIT,ML,8.95,M,15.94,D,9.30,M*15
```

## Section 7 - Care & Maintenance

The battery is the only user-replaceable parts in the TruPulse 200X. Do not remove any screws. To do so will affect or void the LTI Limited Warranty.

### *Operating Temperature*

The instrument is rated for an operating temperature range of -4 to +140° F (-20 to +60° C). Do not expose the TruPulse 200X to temperatures outside this range.

### *Moisture and Dust Protection*

The TruPulse 200X is sealed to provide protection from normally expected field conditions. It is protected from dust and light moisture.

- ① If water leakage is suspected:
  1. Power OFF the TruPulse 200X.
  2. Remove the battery.
  3. Air dry the TruPulse 200X at room temperature with the battery compartment open.

### *Shock Protection*

The TruPulse 200X is a precision instrument and should be handled with care. It will withstand a reasonable drop shock. If the unit suffers from a severe drop shock, you may need to send the unit to LTI for service repair.

### *Aligning the Tilt Sensor*

The TruPulse 200X tilt sensor cannot be realigned in the field. If you have problems with inclination measurements, contact Laser Technology, Inc. to arrange to return the instrument to the factory for realignment.

### *Transporting*

When transporting the TruPulse 200X, the unit should be secured in the provided carrying case. The provided neck strap can be used when carrying the TruPulse 200X in the field.

### *Cleaning*

Clean the TruPulse 200X after each use, before returning it to its carrying case.

Check all of the following items:

- *Excess moisture.* Towel off excess moisture and air dry the instrument at room temperature with the battery removed and the battery compartment open.
- *Exterior dirt.* Wipe exterior surfaces clean to prevent grit buildup in the carrying case. Isopropanol may be used to remove dirt and fingerprints from the exterior.
- *Dirty lenses.* Use a lens brush to remove surface dust and loose particles from the front panel lenses. To clean a lens with a clean cloth or lens tissue.
- *Transmit and Receive Lenses.* Use the provided lens cloth to wipe the lenses. Failure to keep the lenses clean may damage them.

### *Storing*

If you will not be using the TruPulse 200X again soon, remove the battery before storing the instrument.

## Section 8 - Specifications

All specifications are subject to change without notice. Please refer to LTI's website for current specifications. If you are not able to locate the information on the website or if you do not have internet access, please contact LTI via phone or fax. Please contact LTI to request more detailed information about user self-calibration instructions and information

<b>Weight:</b>	13.5 ounces (382 g)
<b>Size:</b>	5.2 x 2.1 x 4.5 in (13 x 5 x 11 cm)
<b>Data Com:</b>	Serial Port and Bluetooth
<b>Max Range:</b>	0 to 8,200 ft (0 m to 2,500 m) to reflective target 3 to 6,233 ft (0 m to 1,900 m) typical to non-reflective
<b>Range Accuracy:</b>	$\pm 1.6$ in ( $\pm 4$ cm) typical targets <400m; $\pm 6$ inches ( $\pm 15$ cm) typical targets < 1000m $\pm 1.6$ in ( $\pm 4$ cm) to $\pm 1$ ft ( $\pm 30$ cm) to distant and weak targets*  *Note: Target quality can be affected by atmospheric conditions, such as heat shimmer, dust, target reflectance, traverse angle to target and beam spread.
<b>Range Resolution:</b>	1 inch, 0.1 yard, 1 cm
<b>Inclination Accuracy:</b>	$\pm 0.1$ degree typical Improper set up can result in deviation of the specified accuracy
<b>Inclination Limits:</b>	$\pm 85$ degrees
<b>Inclination Resolution:</b>	0.1 degrees, 0.1%
<b>Inclination Units:</b>	Degrees, % Slope
<b>Power:</b>	3.0 volts DC nominal; (1) CR123A battery (Alkaline, NiCd/NiMH, Lithium)
<b>Battery Duration:</b>	12 Hours Continuous Use
<b>Environmental:</b>	Water and dust resistant; IP 55
<b>Temperature:</b>	-4 to +140° F (-20 to +60° C)

<b>Eye Safety:</b>	FDA Class 1 (CFR 21)
<b>Optics:</b>	7X magnification with field of view: 330 ft @ 1,000 yds (100 m @ 915m away)
<b>Display:</b>	In-scope LED
<b>Range Units:</b>	Feet/Inches, Meters/Centimeters, Yards
<b>Inclination Units</b>	Degrees, Slope %
<b>Declaration of Conformity:</b>	Contact LTI for details. See inside front cover for LTI contact information





## Section 9 - Main Display LED Characters

The LED Main Display and Lower Display are used to convey messages and measurement results. When all of the indicators are active

Main Display: 8888

Lower Display: 888

Numbers 0-9: 0 123456789

Alpha Characters:

A = a	G = g	P = p
b = b	h = h	r = r
C = c	l = i	S = s
d = d	L = l	t = t
E = e	n = n	U = u
F = f	o = o	

Due to the limited number of characters available, many messages have to be abbreviated. The table below lists the messages that appear in the Main Display.

Message	Explanation	Page #
An 1	Angle 1 Height Routine	36
An 2	Angle 2 Height Routine	36
bAud	Baud rate	28
br	LED brightness	20
bt	Bluetooth	29
c	High quality target	7
ClO	Closest Target Mode	25

Message	Explanation	Page #
Con	Continuous Mode	23
dEG	Degrees	21
EnC	Bluetooth Copy Mode (Reserved for future use with the MapStar TruAngle)	29
FAr	Farthest Target Mode	24
F ILt	Filter Mode	22
gAt	Gate Value	26
gAtE	Gate Mode	26
oFF	Off	various
on	On	various
PEr	Percent Slope	34
Sh 1	Shot 1 Missing Line Routine	40
Sh 2	Shot 2 Missing Line Routine	40
Shot	Shot 1 Height Routine	35
Std	Standard Target Mode	24
tArG	Targeting Mode	24
Un It	Unit	21

## **Section 10 – LTI Limited Warranty**

### **Standard Limited Product Warranty**

Laser Technology, Inc. ("LTI") warrants products it manufactures to be in good working order, free from defects in materials and workmanship, for a period of 12 months from the date of purchase from LTI or an authorized LTI dealer.

In order to activate your one-year Limited Warranty, please register at [www.lasertech.com/warranty](http://www.lasertech.com/warranty). If you do not have Internet access, please complete the Limited Warranty Registration Card, and return to Laser Technology, Inc. (LTI), within 30 days of purchase.

### **Warranty Exclusions**

To the fullest extent allowed by law, LTI hereby disclaims all other express or implied warranties for the product, including, without limitation, any warranty as to merchantability or fitness for a particular purpose.

This limited warranty does not include service or repair of damage to the product resulting from accident, disaster, misuse, abuse, non-LTI modification of the product, batteries or damage caused by batteries used in our products. If your product uses LTI software which requires registration, that registration must also be completed to benefit from this limited warranty. Software reproduction is forbidden. LTI has no obligation to modify or upgrade a product once sold.

### **Limitation of Liability**





In no event will LTI be liable for damages including any lost profits, lost savings or other incidental or consequential damages arising from the use or inability to use such product. Furthermore, LTI shall not be held responsible if an LTI authorized dealer has been advised of the possibility of such damage, or for any claim by another party. Any responsibility and/or liability of LTI shall be limited to the maximum amount to the original purchase price.

### **Remedy**

To obtain service during the one-year warranty period, call LTI's Service Center or visit [www.lasertech.com/customer-service](http://www.lasertech.com/customer-service) for a Return Merchandise Authorization number. Send the product to LTI or an Authorized Service Center with proof of purchase date. If the product is delivered by mail, you agree to ensure the product or assume the risk of loss or damage in transit, and to prepay shipping costs for door-to-door delivery. LTI will, at its option, repair or replace the product at no additional charge, except as set forth within this limited warranty. Replacement parts and products may be new or reconditioned. Replaced parts or products become the property of LTI.

## Section 11 – Troubleshooting

\*\*See [Page 30](#) for Bluetooth troubleshooting information.

Problem	Remedy
The unit does not power ON or the LED does not illuminate.	Press  . Check and if necessary, replace the battery or batteries.
The target cannot be acquired.	Make sure the unit is powered ON. Make sure that the transmit and receive lens are not obstructed.  Make sure the unit is held steady while pressing  .  Make sure that you press-and hold  as long as the laser is active (10 second maximum). If not using a reflector, make sure that Filter Mode is OFF.
The TruPulse 200X does not have an OFF button:-	Simultaneously press-and-hold  and  for 4 seconds.  To conserve battery power, the unit turns itself off if no button presses are detected after a specified length of time: <ul style="list-style-type: none"> <li>• With Bluetooth OFF: 2 minutes</li> <li>• With Bluetooth ON: 30 minutes</li> </ul>
Incorrect measurements.	The tilt sensor may need to be aligned. Contact LTI for assistance. See inside front cover for LTI contact information.